

# PARIS MIRROR

PRODUCT SPECIFICATION

SKU :GALA224363000 / 6000 / CCT / RGBW

# GALAXY II

FRONT-LIT MIRROR

24 X 36 IN



## FEATURES AND BENEFITS

- LED TECHNOLOGY
- HANGS VERTICALLY AND HORIZONTALLY
- ENERGY EFFICIENT
- CRI 90+
- DIMMABLE WITH ANY STANDARD MLV/ TRIAC DIMMER WALL SWITCH
- UL CERTIFIED
- DURABLE ( UP TO 120 000 HOURS )
- 5 YEARS WARRANTY

## AVAILABLE OPTIONS

- 6000K LED
- 3000K LED
- CCT LED 2700-6000K
- RGBW LED

## LIGHTING SPECIFICATION

- DIMENSIONS : 24X36 in
- WEIGHT : 27 POUNDS (LBS)
- IP RATING: 44
- INPUT VOLTAGE: 110V
- CRI: 90+

## SAFETY SPECIFICATION

- ENTIRE ASSEMBLY MEETS UL/cUL STANDARDS
- INTERNATIONAL CERTIFICATIONS
- SAFETY - BACKED MIRROR

# PARIS MIRROR

PRODUCT SPECIFICATION

SKU :GALA224363000 / 6000 / CCT / RGBW

# GALAXY II

FRONT-LIT MIRROR

24 X 36 IN

MODELS :

Base model	Kelvin temperature	Dimensions	Lumens	Power requirements
<b>GALA224363000</b>	3000K	24"W x 36"H x 1.7"D (609mm x 914mm x 43mm)	3450	110 VAC , 29w
<b>GALA224366000</b>	6000K	24"W x 36"H x 1.7"D (609mm x 914mm x 43mm)	3550	110 VAC , 29w
<b>GALA22436CCT</b>	CCT	24"W x 36"H x 1.7"D (609mm x 914mm x 43mm)		110 VAC
<b>GALA22436RGBW</b>	RGBW	24"W x 36"H x 1.7"D (609mm x 914mm x 43mm)		110 VAC

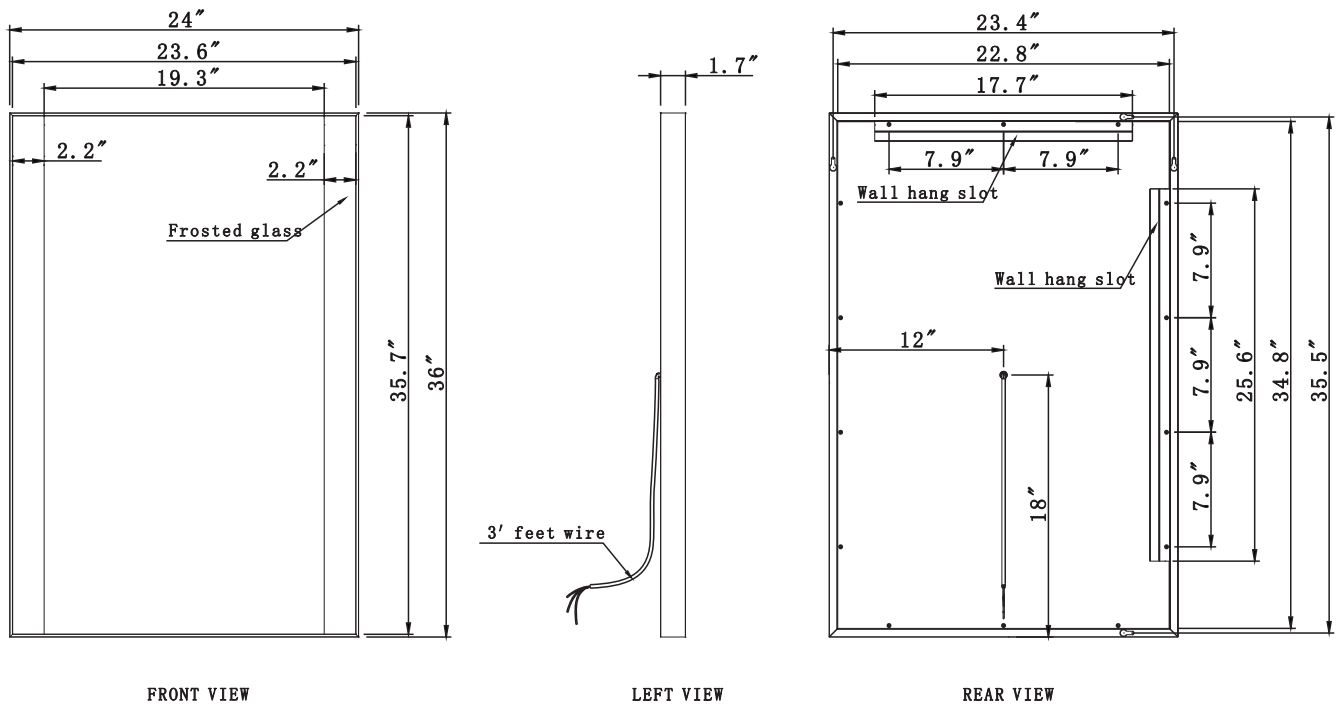

## INSTALLATION & AFTER CARE INSTRUCTIONS:

- 110V HARD WIRED ELECTRICAL CONNECTION
- Z BAR INCLUDED
- MIRROR SHOULD BE CONTROLLED BY AN ON/OFF WALL SWITCH
- INSTALLATION WIRING MAY BE DIFFERENT WITH MIRRORS EQUIPPED WITH ADDITIONAL OPTIONS.

# PARIS MIRROR

PRODUCT SPECIFICATION

SKU :GALA224363000 / 6000 / CCT / RGBW

# GALAXY II

FRONT-LIT MIRROR

24 X 36 IN

## INSTALLATION & AFTER CARE INSTRUCTIONS:

### Installation:

All Paris Mirror backlit and LED mirrors have been independently tested for compliance with electrical equipment (safety) regulations.

All illuminated and backlit mirrors are IP44 rated.

Illuminated mirrors have been designed and independently tested for compliance to electrical equipment (safety) regulations, and are UL Certified.

LEDs have a life expectancy of 120,000 hours of continuous use. All LED light fittings are replaceable and are available through Paris Mirror customer service.

**IMPORTANT:** Always switch off the electrical supply at the mains during installation and maintenance. It is recommended that fuse

is withdrawn or circuit breaker switched off before installation begins.

Fitting in Bathrooms is subject to all regulations. It is not suitable for product installations in Saunas, Steam Rooms, or shower cubicles, and it is recommended for permanent installation.

### Care Safety:

Wear suitable eye wear protection when drilling. Use caution when using power tools near water, beware of hidden cables or pipes.

Take care if drilling on tiled surfaces in case the drill slips. A piece of masking tape applied to wall before marking out fixing holes will stop drill from moving.

### Cleaning & Maintenance:

It is recommended that the unit is cleaned with a soft, dry, non-abrasive cloth when turned off.

Never use cleaning agents or abrasive material on any type of surface finish.

Do not strike glass components with hard or pointed items.

Do not place very hot or cold items against or close proximity to glass surfaces.

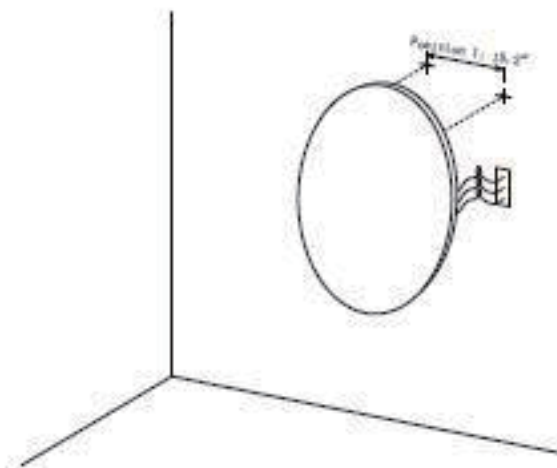

120V DIMMABLE LED DRIVER INCLUDED

- 1- Decide on wall positional placement.
- 2- Prepare & install wall hooks measured to distance between mirror's anchors.
- 3- Match & attach 3 electrical wires from mirror to home electrical wires:  
Live to Live, Ground to Ground, Neutral to Neutral.
- 4- Hang and affix to wall.